

MCSe Operator Manual

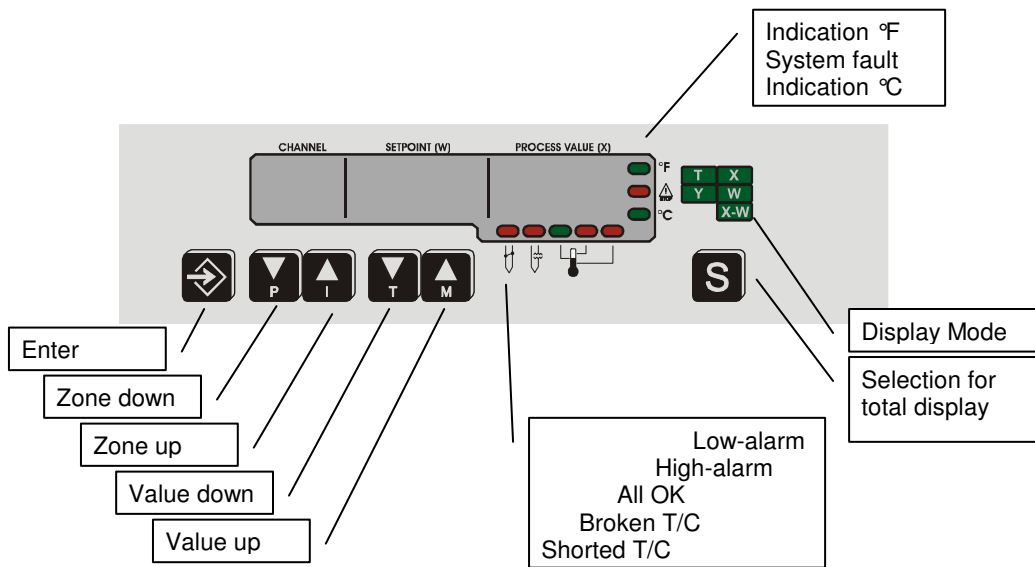

Survey of operation



Controller level		Parameter level
Zone n	<>	Parameter 1..28, Zone n
.	<>	.
.	<>	.
.	<>	.
Zone 2	<>	Parameter 1..28, Zone 2
Zone 1	<>	Parameter 1..28, Zone 1
OU Outputs		SC Slowest Zone
P Program		Ct Comb. Heat. temp.
LO Lo-Value		HI Hi-Value
Id ID		CL Classification

← Enter + P-key →

First Commissioning (see Chap. 5.1)

- Important operation for the first identification:**
- After switched on press the S-key during the indication *S = OU OFF* or use the function *OU OFF* (Chap. 2.6.1) to turn off the outputs.
 - Enter a setpoint for the installed zones.
 - Turn on the outputs by the function *OU Start*.

Contents

1.	Variation of the units	5
1.1	Safety attention	5
1.2	Operation elements	6
1.3	Equipment and functions	6
2	Operation	7
2.1	Indication	7
2.1.1	Controller indication	7
2.1.2	Control mode in the setpoint section	7
2.1.3	Total display	8
2.2	Keyboard	8
2.3	Protection by password	9
2.3.1	Unlocking and locking the unit	9
2.3.2	The password level	10
2.4	Operation levels	10
2.5	The controller level	11
2.5.1	Switch outputs on or off at the start of the unit	11
2.5.2	Control-loop-identification	11
2.5.3	Selection of a zone	12
2.5.4	Input of setpoints	12
2.5.5	Limits of setpoints	12
2.5.6	Selection of the control mode (manual mode)	12
2.6	Global parameters in the control level	14
2.6.1	OU-parameter (Outputs)	14
2.6.2	P-parameter (program)	14
2.6.3	Lo-parameter (Lo-value)	15
2.6.4	Id-parameter (ID-Code)	15
2.7	Alarms and reasons	15
2.8	Supervision of the zones	18
2.8.1	Softstart for heating up	18
2.8.2	Supervision of current-leakage	18
2.8.3	Combined heating up	18
2.9	Thermal control	19
2.9.1	Recognition of shorted sensors	19
2.9.2	Recognition of defective (shorted) power relays	19
3	Examples for the operation	20
3.1	Input of a setpoint	20
3.2	Change the program	20
3.3	Change the operation mode	21
3.4	Change parameters	22
4	Parameters of the zones	23
4.1	Selection and setting of a parameter	23
4.2	Reset the original parameters	24
4.3	The parameters	24
4.3.1	PARAMETER 1: Lo-alarm	24
4.3.2	PARAMETER 2: Hi-alarm	24
4.3.3	PARAMETER 3: Deviation-alarm	24
4.3.4	PARAMETER 4: x_p for heating	25
4.3.5	PARAMETER 5: t_n (integral part for heating)	25

4.3.6	PARAMETER 6: t_V (differential part for heating)	25
4.3.7	PARAMETER 7: ramp up	25
4.3.8	PARAMETER 8 – 10 are not available	26
4.3.9	PARAMETER 11: Supervision time	26
4.3.10	PARAMETER 12: softstart	26
4.3.11	PARAMETER 13: combined heating	26
4.3.12	PARAMETER 14 - 18 are not available.	27
4.3.13	PARAMETER 19: mean output rate	27
4.3.14	PARAMETER 20 - 24 are not available	27
4.3.15	PARAMETER 25-28: values of the setpoint programs 1-4	27
5	Configuration of the unit	28
5.1	Commissioning	28
5.1.1	Connection	28
5.1.2	Input of setpoints	28
5.1.3	First Control-loop-identification	28
5.1.4	Important operation for the first identification	28
5.1.5	Identification after switch-on	28
5.1.6	Identification after start function	29
5.1.7	Wrong operation	29
5.1.8	Heating up	29
5.1.9	Finish	29
5.2	Global parameters in the parameter level	29
5.2.1	Sc-Parameter (slowest zone)	29
5.2.2	Ct-parameter (combined heating)	30
5.2.3	Hi-parameter (Hi-value)	30
5.2.4	CL-Parameter (Classification)	30
5.2.5	IC-parameter (ID code)	31
5.3	Indication of the internal setpoint	31
5.4	Indication of the interface address	31
5.5	Indication of the unit data	31
5.6	Selftuning	32
5.6.1	Rules for selftuning	32
5.6.2	Oscillation trial	33
5.6.3	Start-up trial	33
5.7	DIP-switches	34
6	Technical data	35
6.1	Alarm contact	35
6.2	Plug signification	35
6.3	Protection against net-voltage	36
6.4	Rear view for 8 zones	37
6.4.1	Technical data	38
6.5	Hints to EMC (electro magnetic compatibility)	39
6.6	Headword-index	39

1. Variation of the units

The units of the **MCSe** series are carried out in 2 basic variations. The controllers are available for 2 to 8 zones and in a twin version from 9 to 16 zones.



1.1 Safety attention

The **MCSe** units have to be connected to the specified supply net. The local and the general rules have to be observed for the installation and operation.

The units have to be wired and commissioned by authorized persons.

Maker and vendor of the unit are not liable for direct and indirect damage or loss due to wrong handling.

It does not protect of dangerous voltage at the outputs to switch off all outputs or single zones!

The referring plugs or the complete **MCSe unit has to be disconnected from the supply net before maintenance of the connected heaters!**

Disconnect the **MCSe unit from the supply net before open the cover!**

1.2 Operation elements

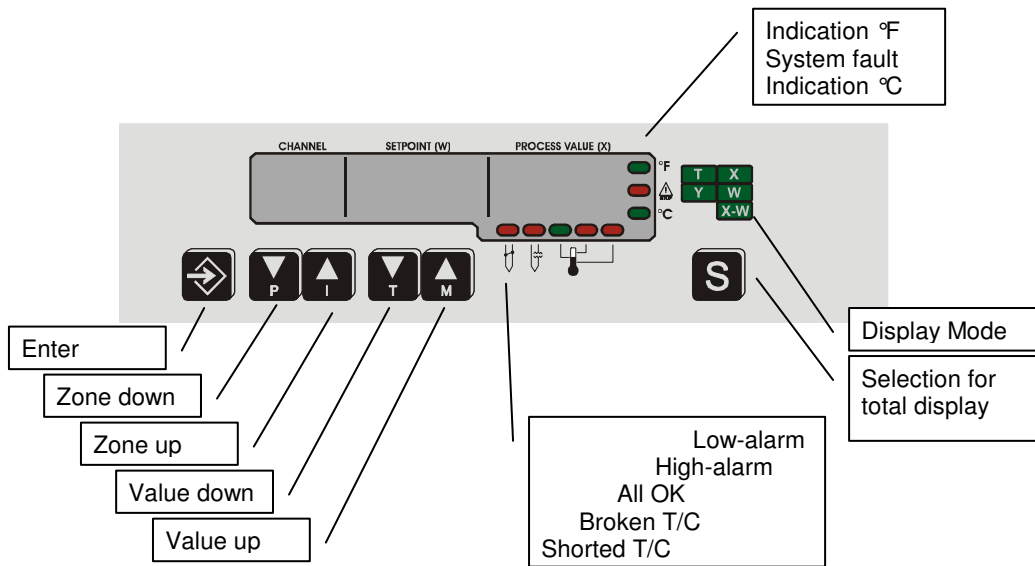

1.3 Equipment and functions

All units include the same functions which are described in the following:

- Control-loop-identification for hot runners
The controller classifies inert from very fast zones.
- Softstart for hot runners
Cold zones get heated smoothly.
- Combined heating
All zones heat up at the same speed, waiting for the slower ones.
- Supervision of leakage current with fast dry out
When current leakage is recognized, the setpoint will be internally limited at 100°C.
- Selfsetting of parameters
Self tuning of control parameters to each control loop.
- Protection against net-voltage
The sensor inputs are protected against overvoltage by a special fuse module.
- 4 setpoint programs
4 setpoints are available for each zone, the respective one of these is activated.
The desired setpoint program may also be activated by external PLC-inputs.
- Classification of the control loops selectable
Individual settings of the zones may be kept permanently.
- SSR Supervision
Shorted outputs will be indicated.

2 Operation

2.1 Indication

2.1.1 Controller indication



The controller indication is divided into three sections:

- number of the zone (here 3)
- setpoint of the zone (here 230)
- actual value of the zone (here 229).

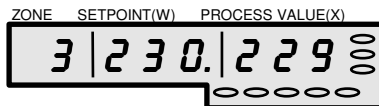

A decimal point appears behind the setpoint, if an internal setpoint is enabled.

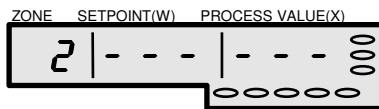

A zone is switched off, if the setpoint is set below the Lo-value. This is shown by six dashes.

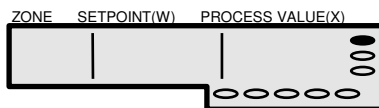

°F-indication

The temperatures are indicated in degrees Fahrenheit.

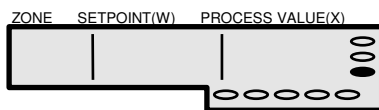

°C-indication

The temperatures are indicated in degrees Celsius.

2.1.2 Control mode in the setpoint section

The control mode is shown in the setpoint section, alternating with the value. The indicated terms have the following significance:

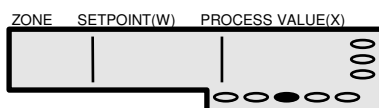

OK-LED, green

lights, when all zones are without alarm.

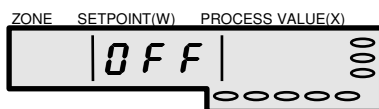

Zone is switched off

See **Change the operation mode**

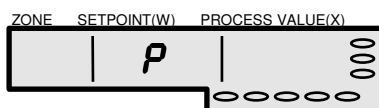

Zone is in manual mode

See **Change the operation mode**

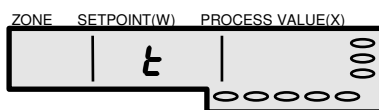

This zone is tuning.

See **selftuning**

Classification is disabled.

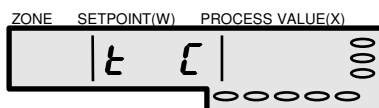

Tuning is running.

Classification is enabled. The results might get overwritten.

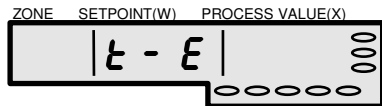

Tuning error. This zone has tripped the tuning routine.
See **selftuning**

2.1.3 Total display

The total display indicates all zones. You may select among all actual values (T; X), setpoints (T; W), differences (T; X-W) or output rates (Y). The alarms of the different zones are shown in each mode.



- T, X: temperature-actual value
- T, W: temperature-setpoint
- T, X-W: temperature-deviation
(actual value - setpoint)
- Y: output rate

The S-key switches the selection for the total display. The display mode is indicated in the LED window.

The LED indication flashes, if the outputs are switched off (OU-parameter = „OFF“).

2.2 Keyboard

There are 6 keys at the unit to select the display and set new values. Some of the keys have the autorepeat-function. I.e. the value setting continues as long as the key is pressed (the speed is increasing).



The S-key switches the selection for the total display. The display mode is indicated in the LED window.

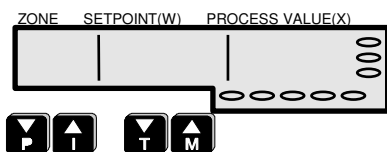

The P-, I-, T-, M-keys

Each of these keys have two functions. If separately operated, the arrows on the keys are valid. This way the zone number and the value may be changed. If they will be operated together with the E-key (E-key first), so the printed letters will be valid. The referring functions are described in the further.



The E-key (Enter)

New flashing settings have to be confirmed by this key.

The pressed E-key activates the 2nd function of the 4 arrow-keys.



The P-key (zone down)

This key steps to the lower zone.

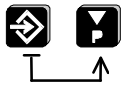

Together with the E-key you enter or rather leave the parameter level.

The I-key (zone up)

This key steps to the upper zone.

The T-key (value down)

This key decreases the indicated values.

Together with the E-key the selftuning will be switched on or off for this zone.

The M-key (value up)

This key increases the indicated values.

Together with the E-key the referring zone will change the operation mode. (Auto -> Manual -> Off -> Auto -> . . .).

2.3 Protection by password

The **MCSe** controller is protected against unauthorised operation. The identification is demanded by the password. The level of protection and the password may be changed. The unit stays unlocked if the Id-level is set to „0“.

2.3.1 Unlocking and locking the unit

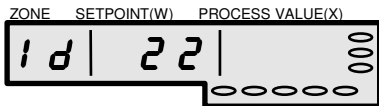

The password will be demanded if required or may be set by the Id-parameter in the control-level.

The original password of the **MCSe** units is **22**.

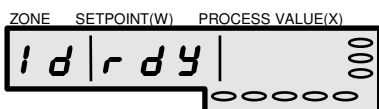

If the correct password was entered, this indication appears. From now on the unit is unlocked and all settings are able.

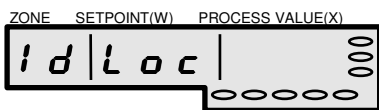

After wrong code or pressing the E-key twice, the unit will be locked and indicate:

The unit may be protected against settings according to the IL-parameter (ID-Level = 1...3).

The unit will lock automatically after a duration of 5 minutes without any operation by the keys.

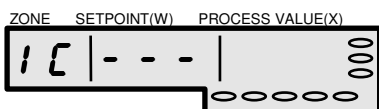

The password may be changed by the IC-parameter in the parameter-level. After new setting only this indication appears without the password. So it is only known to the referring operator.



The setting of a new password should be done well considered and carefully. Otherwise faults during the setting could cause, that even the setting operator does not know the password. In cases of emergency a phone call to the maker will help.

2.3.2 The password level

Operation is enabled and all values and parameters are indicated anyhow. The ID-password opens the Id-level to change the settings.

The following settings are open:

- reset to original settings
- change the operation mode
- change parameters 1...28
- change setpoint, output rate
- OU-parameter
- P-parameter
- Lo-parameter

2.4 Operation levels

The unit has two operation levels. The **controller level** and the **parameter level**. The E- and P-key change between these levels. The controller level will appear always after start of the unit. This allows to change setpoints, operation-modes and so on. The parameter level is indicated by the decimal points in the zone- and process-sections. It allows to change the control parameters and some of the global parameters.

Survey of the two operation levels

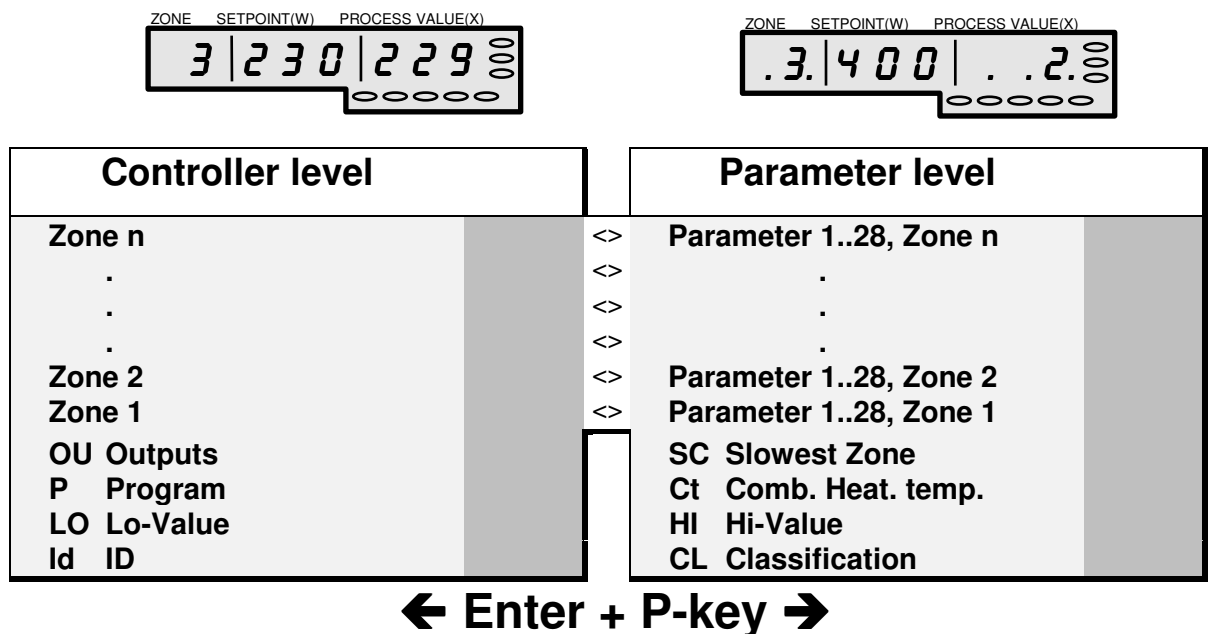

E-key together with the P-key enters or leaves the parameter level.

2.5 The controller level

This is the level for normal operation. Setpoint, operation mode and so on will be changed here. It must be left only for parameter settings.

2.5.1 Switch outputs on or off at the start of the unit



After the start of the unit this text will alternate with the program version for some seconds. If no key is pressed, the unit will start the control mode automatically.

If the S-key is pressed during this period, so the outputs will keep switched off at the end of the loading phase.

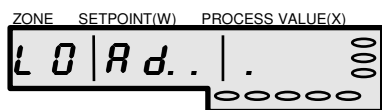

This indication shows the initialisation phase of the processor.

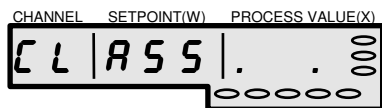

During this period the classification is running, if it was not switched off.

Also when the actual values are >60°C and do not comply to the conditions, this setting will be indicated for 3sec.

Alternative:

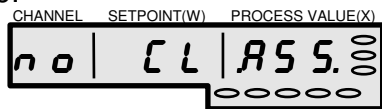

This short message is a hint, that the classification was switched off.

Alternative:

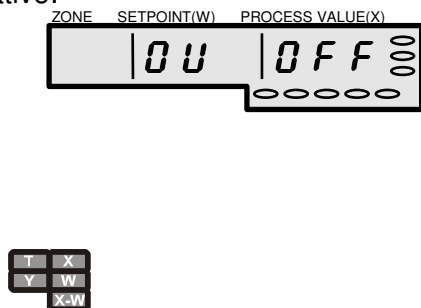

The OU-parameter will indicate „OFF“ immediately. This gives the chance to switch off the outputs before they are powered. Now the unit may be prepared without haste: Set parameters, start the selftuning (important for start-up-tune) or program the setpoints. The OU-parameter will be set to „on“ afterwards. The flashing selection LED indicates that the outputs are switched off.

2.5.2 Control-loop-identification

With normal start of the unit the outputs are switched on. After identification of the unit the activated zones get checked. The unit classifies inert from very fast zones.

Condition: The zones must be activated , the actual values have to be below 60°C.

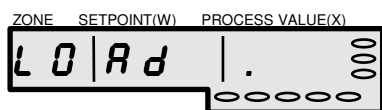

The running point indicates the phase of control-loop-identification.

2.5.3 Selection of a zone

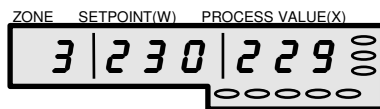

The desired zone may be selected by the two keys (P-, I-key) below the zone section. According to the type of unit you may select a number between 1 and 16.

Below the zone 1 there are 4 global parameters. They have general functions for operation (see **global parameters**).

2.5.4 Input of setpoints

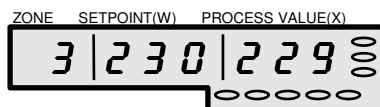

→ ID-Level: locked

The setpoint may be changed for the selected zone. The two keys below the setpoint section (T-, M-key) may change the setpoint. This value is flashing and has to be entered by the E-key.

If you should not enter during the next 10 seconds the display will return to the previous value. Values below the Lo-value will result in dashes. This zone is switched off after enter. A short press on the keys changes the value for 1 degree. Longer operation will increase the steps to 5 or 10 degrees.

2.5.5 Limits of setpoints

The setpoint may be set between the Lo-value and the Hi-value. With the Lo-value or higher a zone is switched on. Decreasing the Lo-value will set the setpoint to zero and switch the zone off. No alarms are indicated for this zone without setpoint. Dashes appear in the display. This way the Lo-value may help setting several zones. An increased Lo-value, up to the desired setpoint, sets the zones by a single step from zero to the desired setpoint.

2.5.6 Selection of the control mode (manual mode)

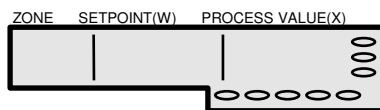

→ ID-Level: locked

The E-key together with the M-key will change the operation mode of the referring zone. The **control mode**, the **manual mode** and „**zone off**“ may be selected.

Disable the manual mode:

The DIP-switch 3 (see chapter DIP-switch) may disable the manual mode in case or leakage current gesperrt sein.

In this case there is no selection of manual mode for any zone available.

If a leakage current is detected in manual mode, the output rate will be set to „0“ % during this time.

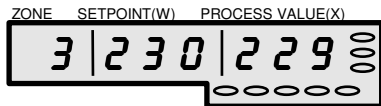

Control mode

The controller display shows:

- zone number (here zone 3)
- setpoint (here 230°)
- and actual value (here 229°).

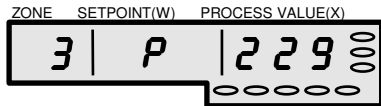

Manual mode

The manual mode is indicated by a flashing „P“ alternating with the output rate. A constant rate may be set here.

The controller display shows:

- zone number (here zone 3)
- output rate (here 0 %)
- and actual value (here 229°).

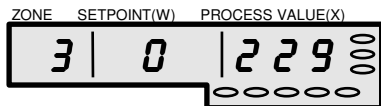

Manual mode without setpoint

The manual mode allows to set a constant rate even for a zone which is switched off (setpoint < Lo-value). No alarms are indicated for this zone.

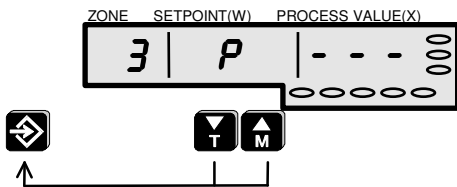

The total display shows a „P“ in the referring zone.

The heaters are no longer controlled in the manual mode as they are powered by a constant rate.

ATTENTION

We strictly point out that the temperature is **not** controlled, when the sensor is broken! When a constant output rate is set, external conditions may change the actual temperature in the control loop. The manual mode is defined for emergency operation to keep the process temporary running. The defective sensor should be replaced as soon as possible.

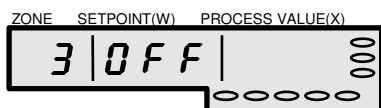

Zone off

This zone (here zone 3) is switched off. But the previous setpoint is kept in opposite to the switching off by a setpoint lower than the Lo-value (setpoint = 0°).



The referring zones stay dark in the total display.

2.6 Global parameters in the control level

These 4 global parameters may be necessary for the operation of the **MCse** unit. They are not responsible for single zones.

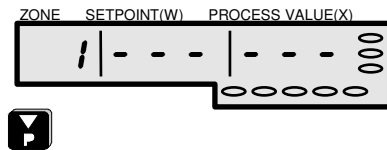

The global parameters are located below the zone 1 (P-key).

2.6.1 OU-parameter (Outputs)

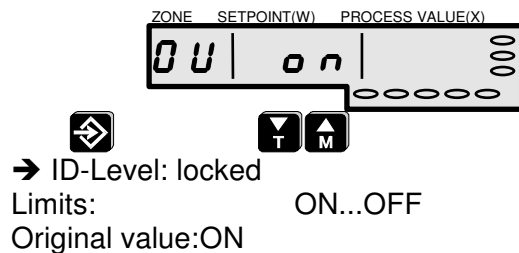

By this parameter all outputs may be switched off generally. The parameter acts like a main-switch for all zones.

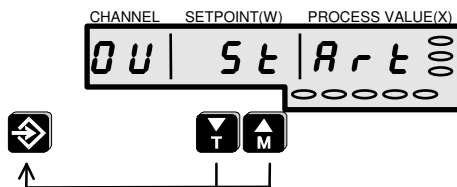

This function allows a restart of the controller to enable the identification of the control loops. The outputs will be switched on.



The flashing selection LED indicates that the outputs are switched off.

The OU-parameter may be set during the „SELECT“ period after the start of the unit.

2.6.2 P-parameter (program)

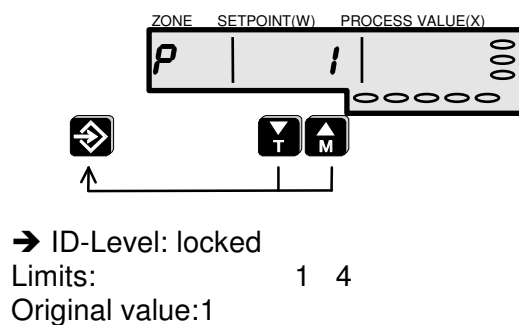

The P-parameter (setpoint programs) selects one of the four setpoint-programs. All zones get a new setpoint after the change of the setpoint program.

The selection of a new program shows the referring setpoints (here 300 °C for each) in the total display before it is confirmed by the E-key. It is not activated as long as the program number flashes in the controller display. An other program may be selected before it will be activated by the E-key.



The setpoint programs are helpful, when all setpoints have to be changed to other values. (e.g. night-decrease, change of product, ...)

2.6.3 Lo-parameter (Lo-value)

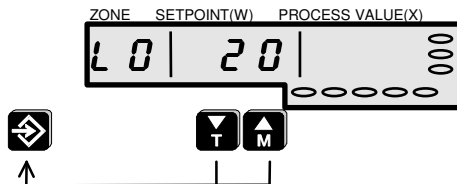

The Lo-parameter (Lo-value) sets the low limit of the temperature setpoints.

→ ID-Level: locked

Limits: 0...Hi-Wert
 Original value:20

The Lo-value may also help setting, if several setpoints shall be changed. Then the Lo-value shall be set to the desired setpoint. The setpoints will be reached by a single step from (---) to one upper degree. Finally the Lo-value should be reset to the former value.

2.6.4 Id-parameter (ID-Code)

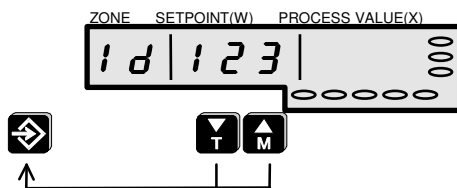

An identification code (ID-Code) of 3 figures may be set here. This code unlocks the unit. See **Protection by password**

→ ID-Level: unlocked

Limits: 0...999
 Original value:22

2.7 Alarms and reasons

Alarms are indicated alternating with the values in the actual value section as well as in the total display. The LED indications are collective reports. The referring zone has be selected to indicate the alarms with the following significance:

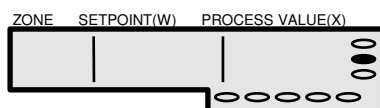

System fault-indication, red

Watchdog, the unit does not work properly any more.

Reason:

- see H-alarm
- see HH-alarm
- Switch the unit off and on.
- Return the unit to the maker for repair.

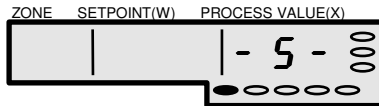

Reason:

Collective alarm for shorted sensor by LED, red

Shorted sensor at this or other zones.
See **parameter 11 supervision time**

- Shorted sensor?
- Mixed polarity of the sensor?
- Sensor has no contact to this zone?
- Output-fuse defective?
- Heater defective?
- Defective triac in the unit?
- Defective output board in the unit?
- Supervision time (Parameter 11) too short?

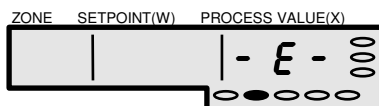

Reason:

Collective alarm for broken sensor by LED, red

Broken sensor at this or other zones.
See **AP-parameter**

- Sensor connected?
- Sensor wiring O.K.?
- Sensor-plugs O.K.?
- Check the NSS fuses in the unit.

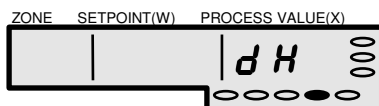

Reason:

Positive temperature deviation with LED, red

This actual value is above the deviation alarm (parameter 3).

- Increase deviation alarm (Parameter 3)
- With continuous alarm start selftuning

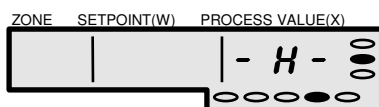

Reason:

Temperature Hi-alarm with LED, red

This actual value is above the HI-alarm (parameter 2). All outputs get switched off until the actual value decreases below the Hi-alarm.

- Alarm limit too close to the setpoint?
- Heating from external?
- Triac defective?

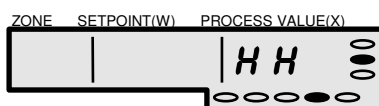

Temperature HH-alarm with LED, red

This actual value is above the Hi-parameter. All outputs get switched off. The controller will go on heating only after switched outputs „OU on“ or restart when the actual value has decreased the Hi-parameter.

Reason:

- Setpoint too close to the Hi-value?
- Heating from external?
- Triac defective?

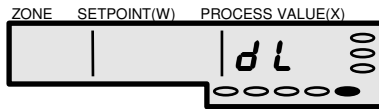

Reason:

Negative temperature deviation with LED, red

This actual value is below the deviation alarm (parameter 3).

- Heating power sufficient?
- Heater defective?
- Output-fuse defective?
- Sensor without contact to this zone?
- Defective triac in the unit?
- Defective output board in the unit?
- Increase deviation alarm (Parameter 3)
- With continuous alarm start selftuning

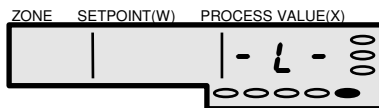

Reason:

Temperature Lo-alarm with LED, red

This actual value is below the Lo-alarm (parameter 1).

- Alarm limit too close to the setpoint?
- Heating power sufficient?
- Heater defective?
- Output-fuse defective?
- Sensor without contact to this zone?
- Defective triac in the unit?
- Defective output board in the unit?

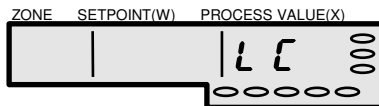

Reason:

Leakage current alarm

Indication for leakage current in this zone, may dry out at 100°C.

- The heater must dry out to avoid damages.
- Isolation between heater and PE defective?

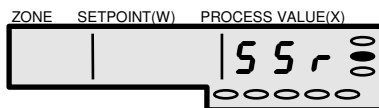

Reason:

Shorted solid-state-relay

See **parameter 11**

- Defective triac in the unit?
- Heating from external?
- Sensor in contact to other heater?

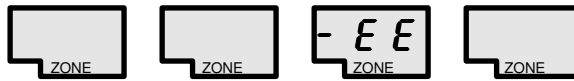

Override

The negative difference in the total display is greater than -99 and might not be indicated. The flashing selection LED indicates that the outputs are switched off.

2.8 Supervision of the zones

2.8.1 Softstart for heating up

Hot runners need to be heated up slowly at low temperatures with a low output rate. The **MCse** units are fitted with a special softstart routine, that enables a careful but time sharing heating in the relevant situation. This function may be inactivated by parameter 12.

2.8.2 Supervision of current-leakage

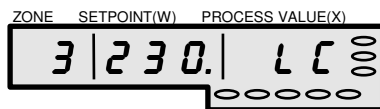

The supervision of current-leakage registers current-leakage from 100 mA on. As soon as a current-leakage is registered, a flashing **LC** (Leak Current) will be indicated in the process value-section. The setpoint is indicated with decimal point.

The referring zone, where the current-leakage was registered, will dry at 100°C. During dry-out the zone will be set internally to 100°C until current-leakage decreases and the humidity will be evaporated.

To avoid thermal asymmetric load, even the zones without current-leakage will be limited at 100°C for the period of dry-out.

The automatical dry-out of the current-leakage zone as well as the dry-out of all zones may be disabled by DIP-switches.

2.8.3 Combined heating up

The combined heating shall avoid a thermal asymmetric load due to slower and faster zones. Synchronous heating of all zones takes care of the tool and prevents of mechanical tension and early worn out.

All zones will be restricted in a certain temperature difference among each other (see **Ct-parameter**) for synchronous heating. So the slowest zone will run by maximum rate. The others will be limited to go ahead with the preset temperature difference. The controller is looking for the coldest zone during heat up (see **SC-parameter**).

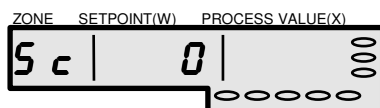

When no coldest zone was found, „0“ appears in the **Sc-parameter** and indicates that no combined heating is active.

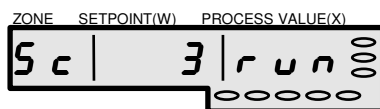

The running combined heating is indicated by „run“. The number shows the coldest zone, which becomes the leader.

2.9 Thermal control

The thermal control indicates shorted sensors and defective power relays. It may be activated at each zone by parameter 11 (supervision time).

2.9.1 Recognition of shorted sensors

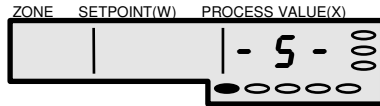

All the following events cause an indication of shorted sensors:

- the zone is in control-mode (setpoint > „0“)
- and the actual value is below the deviation-alarm limit (parameter 3)
- and the controller runs maximum rate for the supervision time (parameter 11)
- and the temperature does not increase for 5° within the supervision.

Acknowledge:

This alarm has to be confirmed by changing or setting the setpoint of this zone.

Mixed up sensors as well as defective heaters will be recognized this way.

In consequence of shorted sensor-alarm the heating will be switched off. The alarm contact will be activated at the same time.



The shorted sensor-alarm may also occur after wrong operation of the unit or wrong parameter settings.

The plausibility routine will interpret an external switch off of the heaters via main isolator as shorted sensor.

The heating up of big and inert zones with undersized heaters may be the reason for shorted sensor-alarm, if the supervision time was set too short.

2.9.2 Recognition of defective (shorted) power relays

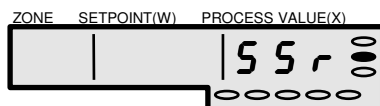

A shorted power relay is recognized, if all following conditions are fulfilled:

- the zone is in control mode (setpoint > „0“)
- and the defined deviation-alarm limit is overridden (parameter 3)
- and the output rate refers to the minimum
- and the actual value increases for further 5° within the supervision time.

All outputs will be switched off in this case (OU = OFF). The alarm contact is active for external purpose.

Acknowledge:

This alarm has to be confirmed by changing or setting the setpoint of this zone.

3 Examples for the operation

3.1 Input of a setpoint

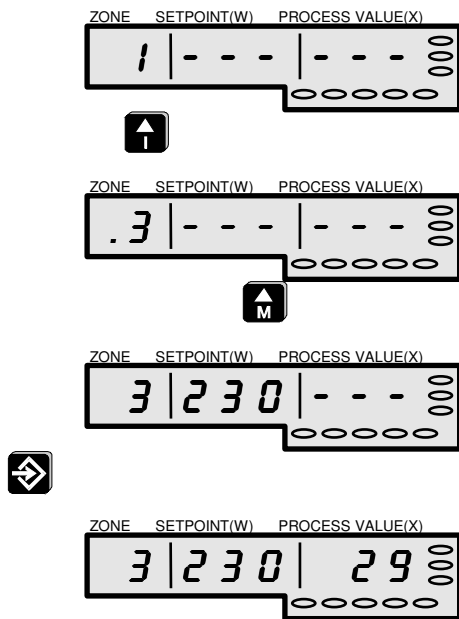

Select the desired zone.

Select the setpoint in this zone.

Confirm this flashing setpoint.

The actual value appears in the display.

3.2 Change the program

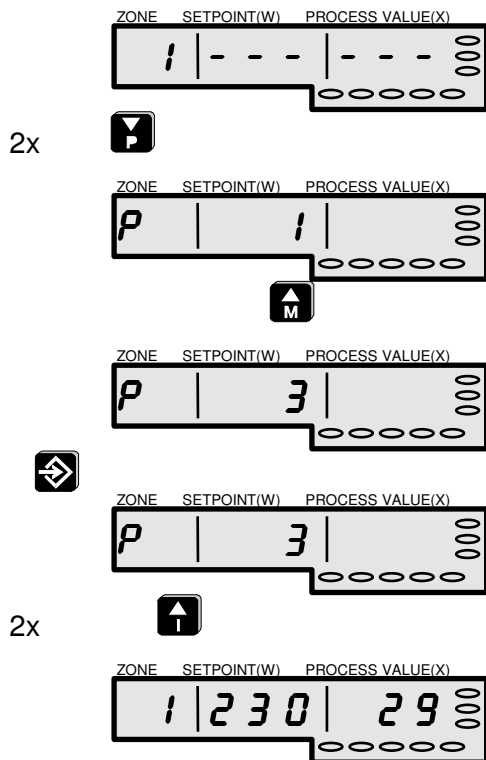

Go to the programs below zone 1.

Select a setpoint program.

Confirm the flashing program number.

Return to the zone indication.

The setpoints of the new program appear in the display.

3.3 Change the operation mode

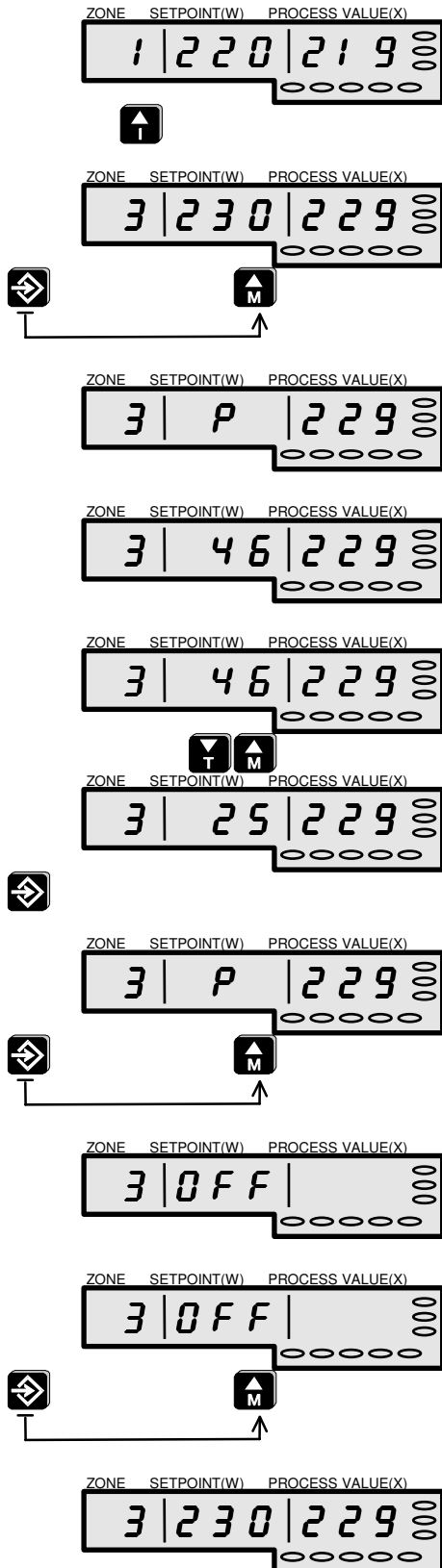

Select the desired zone number.

In this zone press „Enter“ and additional „M“.

In **manual mode** the indication „P“

alternates with the output rate.

The rate may be set between „0“ and „100“.

Confirm the flashing rate.

Press „Enter“ and additional „M“ to reach the next mode.

The zone is **switched off**, when „OFF“ appears in the display.

Press „Enter“ and additional „M“ to reach the next mode.

The setpoint appears in the **control mode**.

3.4 Change parameters

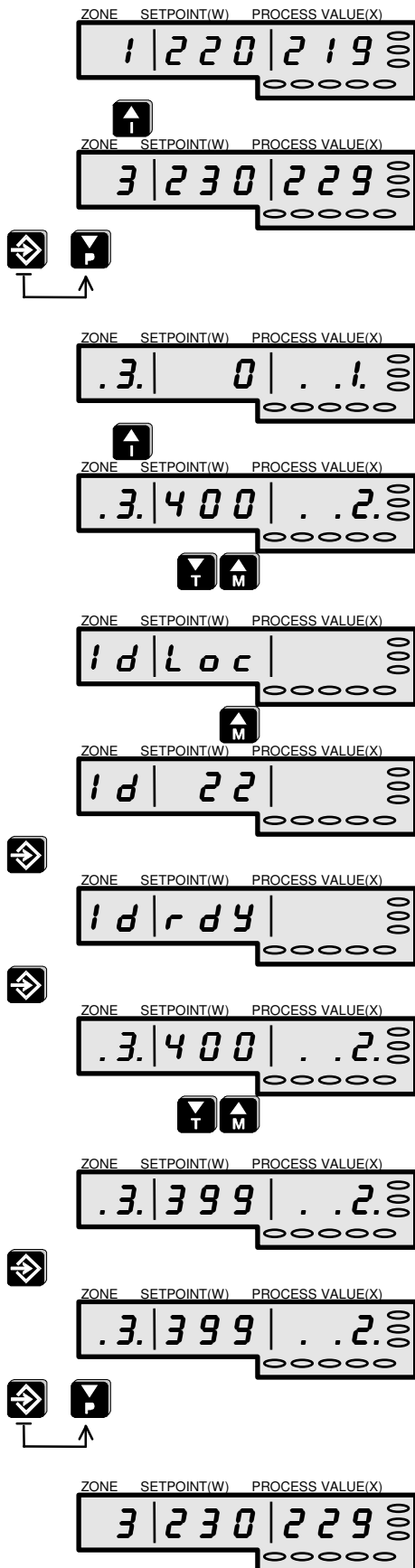

Select the desired zone.

In this zone press „Enter“ and additional „P“.

Select the desired parameter.

Change the selected parameter value.

Enter the pass code if the unit is locked.

Confirm the pass code.

The unit is ready and the operation may be continued.

Change the selected parameter value.

Confirm the flashing parameter value.

Press „Enter“ and additional „P“.

Back in the control level.

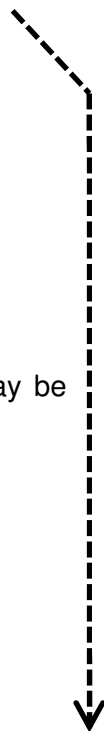

4 Parameters of the zones

- The original settings of the unit are according to (most of) the customer's applications!
- The units may be delivered with original settings according to customer's specification. These differ from the original values in this manual.

Each zone has a set of 28 parameters.

The setpoints of the programs or the alarm limits are simple of parameters for the operation. If the control parameters should exceptionally not result in the desired controlling, we recommend the selftuning. Any change of the PID-parameters require special knowledge about the control loops.

4.1 Selection and setting of a parameter

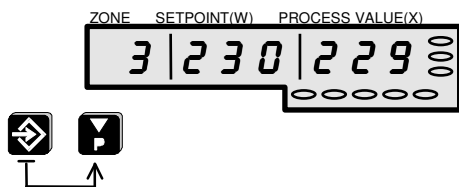

To reach the parameter level press the E-key and additional the P-key. Decimal points in the zone and process section indicate the parameter level.

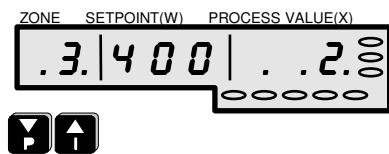

The desired parameter will be selected by the P- and I-keys. Overriding the highest parameter number will enter the next zone, parameter 1. Decreasing below zone 1, parameter 1 you will reach the global parameters.

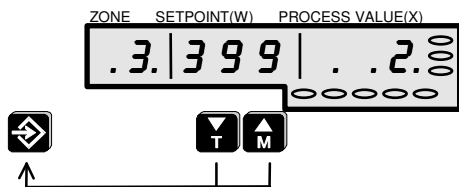

A parameter value will be set by the T- and M-key and confirmed by the Enter-key. These settings are only possible with the referring ID-level.

See **Protection by password**

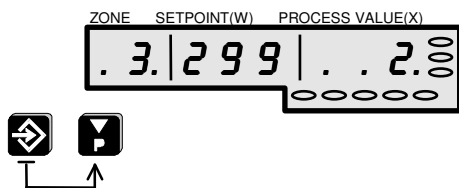

The parameter level will be left by pressing the E-key and additional the P-key.

Additional to the number of the parameter the selected parameter may be identified by the indication of the function. This will be displayed in the upper line of the total display.



Example for the parameter 1, Lo-alarm

4.2 Reset the original parameters

→ ID-Level: locked

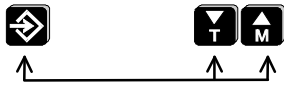

The original parameters will be reset, if the Enter-, T- und M-key will be pressed together for more than 10 seconds. The unit will restart.



**The setting of original parameters overwrites all settings.
The unit returns to the original configuration.**

4.3 The parameters

The function of the different parameters are described in the following.

4.3.1 PARAMETER 1: Lo-alarm

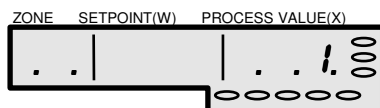

→ ID-Level: unlocked

Limits: 0...999 degree
Original value: 0 degree

The referring zone will indicate Lo-alarm, when the value of parameter 1 will be overridden. This will be indicated by flashing „-L-“ alternating with the actual value. At the same time the low-temperature-LED and the alarm contact will be activated.

4.3.2 PARAMETER 2: Hi-alarm

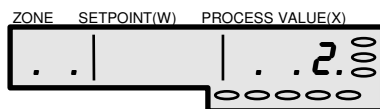

→ ID-Level: unlocked

Limits: 0...999 degree
Original value: 400 degree

The referring zone will indicate Hi-alarm, when the value of parameter 2 will be overridden. This will be indicated by „-H-“ alternating with the actual value. At the same time the high-temperature-LED and the watchdog LED will be activated together with the alarm and the system-alarm contacts.
→ The monitor-channel will indicate HH!

4.3.3 PARAMETER 3: Deviation-alarm

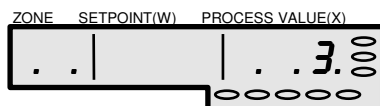

→ ID-Level: unlocked

Limits: 1...999 degree
Original value: 15 degree

As soon as an actual value will deviate for more than the value of this parameter, the referring zone will indicate deviation-alarm. This will be indicated by flashing „dL“ or „dH“ alternating with the actual value. At the same time the high- or low-temperature-LED and the alarm contact will be activated.

4.3.4 PARAMETER 4: x_p for heating

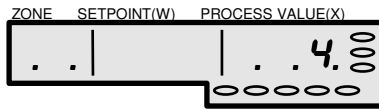

→ ID-Level: unlocked
Limits: 0...100 %
Original value: 7 %

Parameter 4 allows to adjust the proportional part of the control loop *in percent*.

for $x_p = 0$: 2-point controller

The P-band results from the stored Hi-value (original 500°). E.g. a stored x_p -value of 10 and a Hi-value of 500°C result in an effective P-band of 50°.

That means, that a pure P-controller slowly decreases the output rate proportionally within 50° before reaching the setpoint. When the actual value = the setpoint the rate will be reduced to 0%.

Settings of this parameter, that are not changed after classification, will be adapted to the actual Hi-value with each start.

4.3.5 PARAMETER 5: t_n (integral part for heating)

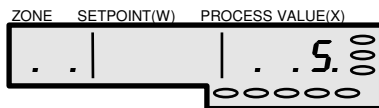

→ ID-Level: unlocked
Limits: 0...999 sec
Original value: 60 sec

Parameter 5 allows to adjust the integral part of the controller in seconds. This component of the controller increases or decreases the output rate with the defined speed according to a possible deviation.

for $t_n = 0$: no I-part

4.3.6 PARAMETER 6: t_v (differential part for heating)

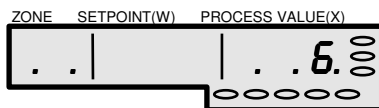

→ ID-Level: unlocked
Limits: 0...999 x $\frac{1}{10}$ sec
Original value: 40 x $\frac{1}{10}$ sec

Parameter 6 allows to adjust the differential part of the controller in 1/10 of a second. This component of the controller 'brakes' the output rate for the stored time, if the actual value approaches the setpoint with too high speed.

for $t_v = 0$: no D-part

4.3.7 PARAMETER 7: ramp up

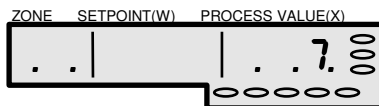

→ ID-Level: unlocked
Limits: 0...999 sec/degree
Original value: 0 sec/degree

When a soft heat up is desired, a heating ramp may be set by parameter 7. This will be active, when:

- the unit has just been switched on
- the setpoint has been increased.

for 0: no ramp

The ramp causes a slow increase of the **internal setpoint** in direction of the programmed setpoint. As soon as the internal setpoint has reached the programmed setpoint, the ramp is out of function until the next change of setpoint.

Pay attention, only the internal setpoint is controlled!

The speed of the ramp for heating up will be set in the sec/degree. That means, that high values cause a slow ramp.

The internal setpoint may be read out in the setpoint-section pressing the T- and M-key.



4.3.8 PARAMETER 8 – 10 are not available

4.3.9 PARAMETER 11: Supervision time

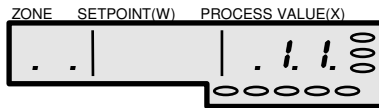

The thermal supervision of the controller (SSR-, S- alarm) may be set here by the time.

- 0: no thermal supervision
- See **Thermal control**

→ ID-Level: unlocked
 Limits: 0...999 sec/degree
 Original value: 0 sec/degree

4.3.10 PARAMETER 12: softstart

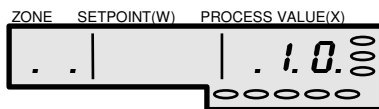

The unit is provided with a softstart routine for smooth heating. This may be enabled or disabled here.

- 0: this zone without softstart
- 1: this zone with softstart

→ ID-Level: unlocked
 Limits: 0...1
 Original value: 1 (Softstart ON)

4.3.11 PARAMETER 13: combined heating

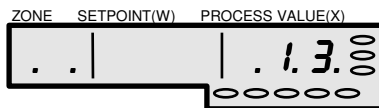

The unit is provided with a combined heating. This may be enabled or disabled here.

- 0: this zone not combined
- 1: this zone combined

See **combined heating**

→ ID-Level: unlocked
 Limits: 0...1
 Original value: 0

4.3.12 PARAMETER 14 - 18 are not available.

4.3.13 PARAMETER 19: mean output rate

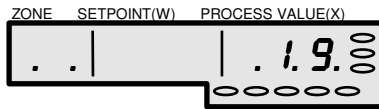

Parameter 19 will define itself during the **normal control mode**. It stores the long period average of the output rate during the control mode.

No input possible

0% after start
 Available 10min after controlling the setpoint

4.3.14 PARAMETER 20 - 24 are not available

4.3.15 PARAMETER 25-28: values of the setpoint programs 1-4

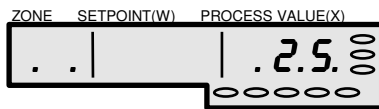

The values of the 4 setpoint programs may be stored here.
 If the setpoint of the actual setpoint program will be changed, this will directly influence the actual setpoint.

→ ID-Level: unlocked
 Limits: 0...999 degree
 Original value: 0 degree

5 Configuration of the unit

5.1 Commissioning

The description for commissioning of the unit is anticipated here. If the below listed steps will be carried out in the described sequence, a failsafe function of the **MCSe** unit is guaranteed. For the better understanding of the different functions we recommend to read this manual.

5.1.1 Connection

- Connection of all heater and sensor cables.
- An alarm generator may be wired to the alarm contact X3 of the unit.*
ATTENTION! Take care of the maximum load of the contacts, see **Technical data**.
- Connection of external PLC signals and interface for computer control, if required.
- Connection to the 3phase supply net.

The signification of the connection-plugs is described in the chapter „Technical data“.

5.1.2 Input of setpoints

- To enter setpoints or setpoint programs you should enter these after the outputs are switched off by the global parameter **OU = Off**. In this mode all values may be set without heating any zone and the important safety functions are not yet valid.
- The entered setpoints are stored in the memory and will be saved even when the unit is disconnected from the power supply.

5.1.3 First Control-loop-identification

The first control-loop-identification refers to a new combination of controller with a tool/hot-runner.

This applies in the following situations:

1. The controller is completely new.
2. The controller was set to original parameters before.
3. The tool and the controller did not run together before. The controller should be set to original parameters (Chap. 4.2).
4. If these values fit no longer, the default parameters should be set (chapter 4.2).

The controller should run through the control-loop-identification to classify the different zones. This phase is indicated by **LOAD . . .** with the running point.

5.1.4 Important operation for the first identification

- After switch on press the S-key during the indication **S = OU oFF** or use the function **OU OFF** (Chap. 2.6.1) to turn off the outputs.
- Enter a setpoint for the installed zones.
- Turn on the outputs by the function **OU StArt**.

5.1.5 Identification after switch-on

The controller with a cold tool will always pass the identification after switch on, if

1. a setpoint was set for all zones min. 10° above the actual value before switched on,
2. the outputs were not turned off before switched on,
3. the actual values were below 60°C before switched on.

5.1.6 Identification after start function

The controller with cold tool will always pass the identification after the function **OU StArt** (Chap. 2.6.1), if

1. a setpoint was set for all zones min. 10° above the actual value before,
2. the actual values were below 60 °C before.

5.1.7 Wrong operation

No classification will occur after.

1. enter of setpoints,
2. different zones are set from manual mode or **OU OFF** to control mode,
3. the outputs are turned on by **OU on**,
4. the actual values are above 60 °C,
5. parameters are changed manually or via tune-function and have not been reset to original parameters,
6. when the classification was switched off, **CLASS OFF**.

The items above have to be considered, if the number of zones will be extended!

5.1.8 Heating up

- Switch the unit on. Now the unit steers towards the stored setpoints, while all relevant functions as softstart, combined heating, supervision of current-leakage, dry-out and current supervision are enabled. These functions and the effects are described in this manual.

5.1.9 Finish

- Observe the heating behaviour. If the regulation behaviour is disturbed (override, nervous regulation, inert regulation) the control parameters of this zone may be found by an optimising trial. See **self tuning** and **rules for self tuning**.
- Define password levels and passwords. To prevent operation by a non authorized person, there is the possibility to define a password. At the same time you may dispose of the authority for operation via password levels. See **protection by password**.

5.2 Global parameters in the parameter level

These general parameters are not relevant for the normal operation of the **MCSe** unit. These settings refer to all zones.

5.2.1 Sc-Parameter (slowest zone)

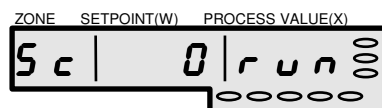

No input possible.

This parameter indicates the combined heating mode by the number of the coldest zone.

See **Combined heating**

5.2.2 Ct-parameter (combined heating)

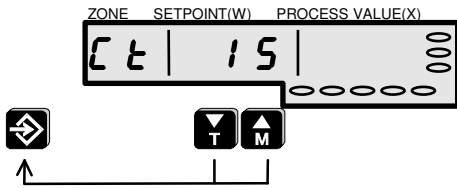

The maximum temperature difference to the slowest zone may be defined here for the combined heating.

- 0: no combined heating for all zones

The combined heating may be switched off for each zone separately by parameter 13.

See **combined heating**

→ ID-Level: unlocked
 Limits: 0... Hi-value
 Original value:15

5.2.3 Hi-parameter (Hi-value)

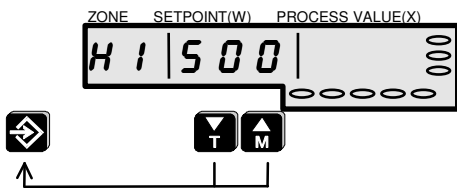

The Hi-parameter (Hi-value) sets the upper temperature limit of the unit. It is also relevant for the controller regulation and should not be changed without considering. Overriding of the Hi-value activates the HH-alarm with the contact of the system alarm and trips the internal mainrelay. All heaters will be switched off. The controller will go on heating only after switched outputs „OU on“ or restart when the actual value has decreased the Hi-parameter.

The referring setpoints will decrease, if the Hi-value will be set below these setpoints.

→ ID-Level: unlocked
 Limits: Lo-value...700
 Original value:500

5.2.4 CL-Parameter (Classification)

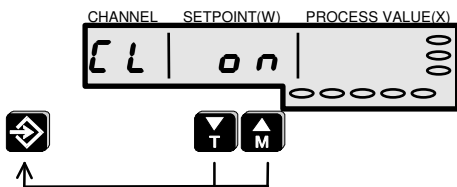

This parameter selects the classification. The classification will be passed directly after the start and creates new settings for P, I and D. Even manual settings may get lost when the conditions have changed meanwhile.

To save special settings, the classification must be switched off.

→ ID-Level: unlocked
 Limits: ON, OFF
 Original value: ON

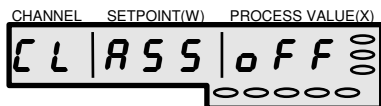

This hint appears after the start to indicate the disabled classification.

5.2.5 IC-parameter (ID code)

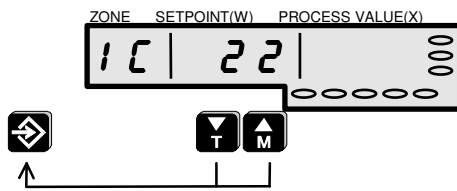

→ ID-Level: unlocked
Limits: 1...999
Original value:22

A new password will be set here. This password has to be entered in the **Id-Parameter** to unlock the unit. After the setting of a new password, the unit will be unlocked automatically.
See **protection by password**.

5.3 Indication of the internal setpoint

The internal setpoint is the actually enabled setpoint of the controller. During normal operation it is identical to the operator's setpoint. The internal setpoint differs only in case of ramps, combined heating a.s.o. This will be indicated by a decimal point in the setpoint section. The internal setpoint may be indicated, too.

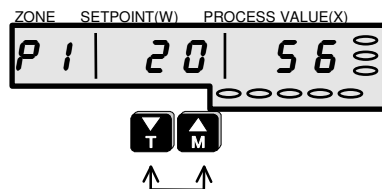

→ ID-Level: unlocked
Limits: 0...100 %
Original value:0 %

Press the T- and M-keys together and the unit will present for the referring zone

- the setpoint program (here P1)
- the internal setpoint (here 20°C)
- the actual output rate (here 56%).

5.4 Indication of the interface address

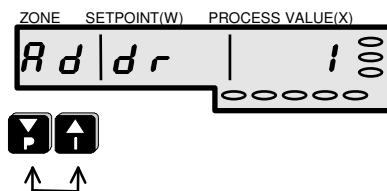

Press the P- and I-keys together and the unit will indicate the interface address.

5.5 Indication of the unit data

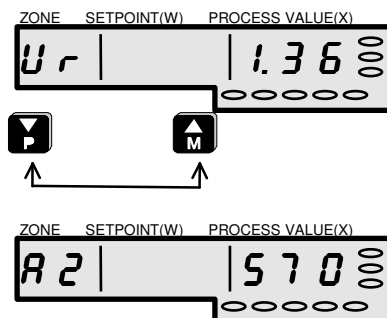

Press the P- and M-keys together and the unit will present in sequence:
software version,

AZ-number,

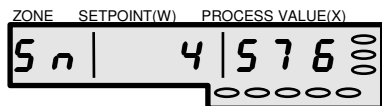

serial number,

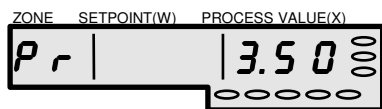

protocol version of the interface,

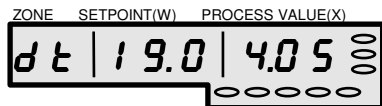

and date of the software.

5.6 Selftuning

The unit may analyse the connected control loops and adjust the P-, I- and D-part by an integrated algorithm.



The tuning will be started for each zone separately with the Enter- and T-key. In this case the following reports will be shown in the setpoint section:

→ ID-Level: unlocked

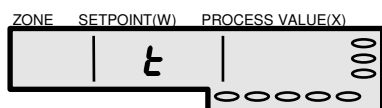

tuning is running
Classification is disabled.

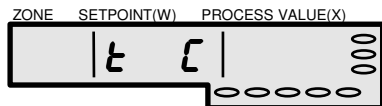

tuning is running
Classification is enabled. The results might get overwritten.

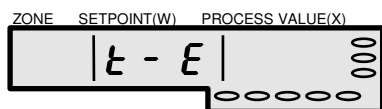

tuning interrupted
(parameters not changed)
This message has to be confirmed by the E-key.



5.6.1 Rules for selftuning

The controller is able to adjust the P-, I- and D-parameters to the control loops by the integrated selftuning. The number of zones can be selected individually.

With the next start, parameters, that have been found during selftuning, will be retained as far as these are in the range of the identification.

The **MCse** includes two different tuning processes. The first routine, start-up trial, optimises the control parameters by determining the delay time and the heat up speed after the start from the cold state. The second routine, oscillation trial, optimises the control parameters by an oscillation trial at a temperature of 80% of the setpoint.

The oscillation trial is more suitable for faster zones, e.g. hot runners. For extremely slow zones, e.g. manifolds, the start trial is more suitable.

The decision, which tuning process to select, determines the controller itself according to the distance to the setpoint. If the actual value is under 80% of the setpoint at the start of the tuning, so the start-up trial will be selected - otherwise the oscillation trial.

The tune mode of the controller should only be used by an operator with a certain background knowledge. The selection among these two methods should be done by the operator knowing the circumstances. He decides at which temperature the tuning should be started.

The tuning will be started by the Enter- and T-keys. The indication for the running tune mode is a flashing **-t-** in the setpoint section. The tuning may be stopped by the same keys.

The tuning may only be started, when:

- a setpoint was set
- the zone is neither switched off nor in manual mode
- no S-, E-, SSR-, LC- or Hi-alarm occurred.

The tuning will trip, if:

- an S-, E-, SSR-, LC-, HH- or Hi-alarm occurs
- the zone will be switched off or change to manual mode
- The setpoint was changed.

The former parameters stay unchanged after trip of the tuning.

5.6.2 Oscillation trial

The requirement for the correct start of the tuning by the oscillation trial is an actual value near the setpoint.

The tuning events in the following sequence:

- internal drop of the temperature setting to 80% of the setpoint
- oscillation trial at full heating rate around this value
- calculation of new parameters resulting from amplitude and frequency of the oscillation
- heating up to the former setpoint using the new parameters.

Disadvantage

Very big and inert zones (e.g. ovens, manifolds) may hardly not be tuned in an acceptable duration on account of the low oscillation frequency. Also thermal coupled zones (e.g. neighbour zones of extruders) may be calculated only conditionally.

5.6.3 Start-up trial

The self tuning by start-up trial should always be selected for slow or thermal coupled heating zones (e.g. extruder heaters).

An actual value well under 80% of the setpoint is required to begin correct tuning in the start-up trial (a cold zone is the optimum). Moreover the temperature at start must be in a stable condition, that means the zone shall neither cool down nor heat up.

At the start of the tuning the zone will be heated by 100% rate, while the gradient of the resulting temperature will be observed. After reaching the maximum the control parameters will be calculated from the maximum gradient and the delay time.

The tuning will trip, if:

- the actual value overrides 80% of the setpoint and no maximum gradient will be found (danger of overheating)
- the actual value decreases although 100% rate (wrong function)
- the actual gradient of the temperature is greater than 1%/sec. (danger of overheating)

A wrong result will be reached, if:

- the start of tuning bases on decreasing temperature values
- the heater was switched off by external isolators at the start of the tuning (results in wrong delay time)

- the start of tuning bases on increasing temperature values, e.g. by previous heating (results in too short delay time).

To avoid the previously mentioned faults during the tuning, the following sequence of operation will be proposed:

- switch off all heaters by the OU-parameter = OFF
- define the setpoints to normal process temperature for the zones
- start tuning for the desired zones
- wait until all heaters are in a stable cold state
- start tuning for these zones simultaneously by enable the heaters by the OU-parameter = ON.

The sequence of the above mentioned items should not be changed in any case, as only by the last item - the enable of the heaters - the internal tuning will start simultaneously. This is an important item for thermal coupled heaters!

5.7 DIP-switches

The reaction of the **MCse** unit with alarm, leakage current and heating shall be selected before commissioning by the DIP-switches.

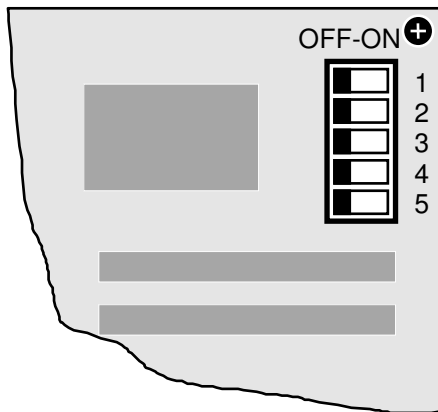

On the CPU board (additionally plugged board) there is a block of five DIP-switches. The following functions may be set here.

The unit has to be turned off before.

The original settings are shows here.

switch	function	ON	OFF	hint
1	alarm	no Lo-, Hi-, Dev-alarm after the setpoint changed	Lo-, Hi-, Dev-Alarm even if the setpoint changed	
2	leakage current	Only indication of current-leakage, no dry-out	Dry-out in case of current-leakage	
3	Manual mode	Manual mode disabled for all zones in case of leakage current ^{x)}	Manual mode enabled even with leakage current	Only disabled, when switch 2 is OFF
4	frequency	60 Hz	50 Hz	
5	degrees	°Fahrenheit	°Celsius	

^{x)} See chapter „Change of Operation Mode“ referring the manual mode.

6 Technical data

6.1 Alarm contact

The **MCSe** units are fitted with an alarm contact at the socket X3. For the position of the socket X3 see **rear view**.

The contact is open without power or in case of alarm (NO). The healthy signal is closed. This way the logic is safe against wire breakage.

Alarm contact

- broken sensor
- shorted sensor alarm
- shorted solid-state-alarm
- current leakage-alarm
- positive temperature deviation-alarm
- negative temperature deviation-alarm
- absolute temperature high-alarm
- absolute temperature low-alarm
- overriding of the Hi-parameter (HH-alarm)
- hardware fault (watchdog)

6.2 Plug signification

The following significations are valid for the basic version of the MCSe units. Units with specified rear boards are not mentioned here.

For the position respective the numbering of the plugs see **rear view**.

Sensor inputs plug X1

contact	sensor	polarity	contact	sensor	polarity
1.	zone 1	+	13.	zone 1	-
2.	zone 2	+	14.	zone 2	-
3.	zone 3	+	15.	zone 3	-
4.	zone 4	+	16.	zone 4	-
5.	zone 5	+	17.	zone 5	-
6.	zone 6	+	18.	zone 6	-
7.	zone 7	+	19.	zone 7	-
8.	zone 8	+	20.	zone 8	-
9.	NC		21.	NC	
10.	NC		22.	NC	
11.	NC		23.	NC	
12.	NC		24.	NC	

Heater outputs socket X2

contact	heater	polarity	contact	heater	polarity
1.	zone 1	N	13.	zone 1	L
2.	zone 2	N	14.	zone 2	L
3.	zone 3	N	15.	zone 3	L
4.	zone 4	N	16.	zone 4	L
5.	zone 5	N	17.	zone 5	L
6.	zone 6	N	18.	zone 6	L
7.	zone 7	N	19.	zone 7	L
8.	zone 8	N	20.	zone 8	L
9.	NC		21.	NC	
10.	NC		22.	NC	
11.	NC		23.	NC	
12.	NC		24.	NC	

Alarm contact socket X3

contact	function	
1.+3.	alarm contact	normally open (NO)

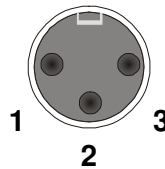

6.3 Protection against net-voltage

The units of the **MCSe**-series are fitted with a fuse module to protect against net-voltage (NSS-module). These modules protect the sensitive electronics for the sensor-inputs against unacceptable high voltage. Such voltage may occur by mixed wiring or by defective heaters.

As soon as a voltage higher than 8V is put to the inputs of the NSS-module, the internal fast fuses will open. The voltage will be contacted to the ground. The controller will indicate a broken sensor for this zone.

The referring zone will be healthy after replacement of the fuse-module. These are special fuses, which are plugged on the specially designed NSS-module. The user may replace by his own. Therefore he has to lift the cover.

6 spare fuses will be delivered in the internal of the original **MCSe** unit.

The cover shows the position of the different fuses.

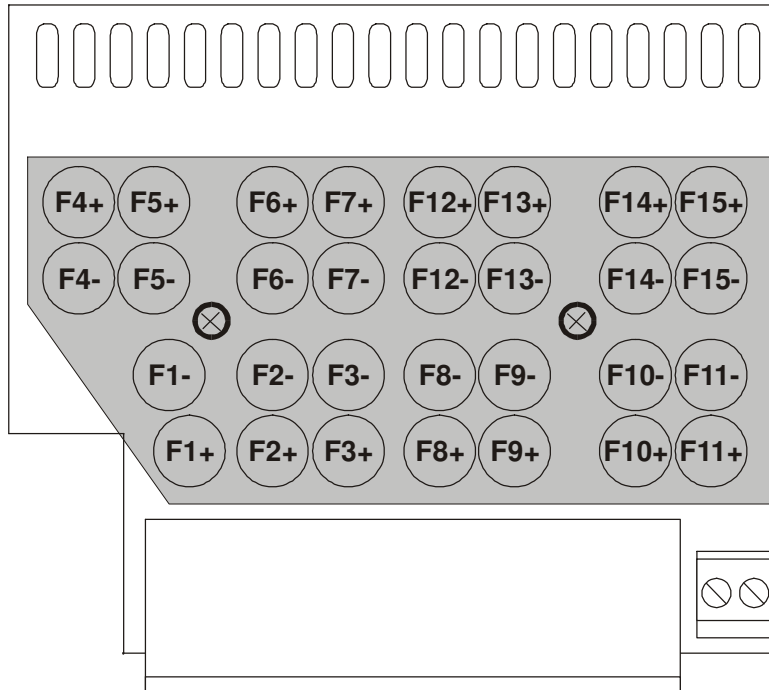

6.4 Rear view for 8 zones

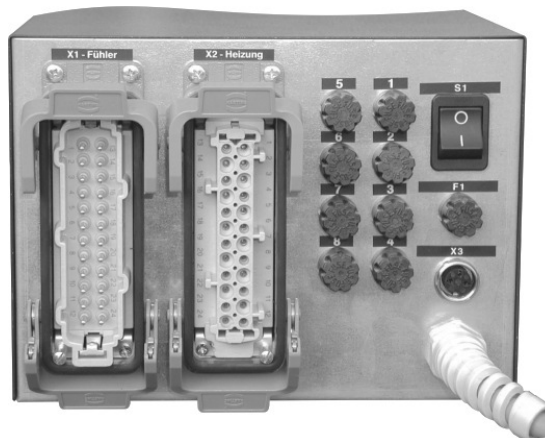

MCSe8 (Example with 24-pin plugs)

6.4.1 Technical data

<u>Supply voltage:</u>	3 phases with loadable N, PE	400 / 230V AC 3-phase, ±10%
<u>Power consumption:</u>		max. 27KW
<u>Netfuses:</u>	Control voltage internal Control voltage external Regulation outputs	1 x 0,8A medium inert (5 x 20mm) 1 x 4A medium inert (6,3 x 32 mm) each 16A super fast (6,3 x 32 mm)
<u>Thermocouple-inputs:</u>	Fe-CuNi type J *)	0..700 °C
	Temperature deviation by cable-resistors	Sensor level depends on wire diameters and length
	Temperature compensation	internal
	Temperature accuracy	±0,25 K
	Temperature actualisation	15 measurements per second
<u>Controller-outputs</u>	bistable, electrical isolated per zone	
	Current per zone	1x heating, 230V contact max. 16A
Current limit for MCSe 2..8	Sum of current per line: Zones 1, 4, 7, Zones 2, 5, 8 Zones 3, 6	each sum max. 16A
MCSe 9..16		32A per line
<u>Collective alarm outputs</u> (Alarm-contact)	Functions: max. voltage max. current	alarm contact, (NO) 24V DC 4A at $\cos\varphi = 1$ 2A at $\cos\varphi = 0,5$
<u>Control routines</u>	PI, PD or PID with automatical and manual control mode, control-parameters to set for all zones separately	
<u>Data memory</u> (EEPROM)	Data storage	min. 10 years
<u>Ambient conditions:</u>	protocol Operation temperature	FE3-Bus version 3.03 0..50 °C
	Cooling	Fan
	Surface temperature of the unit	max. 55 °C
	Storage temperature	-25..+75 °C
	Humidity	< 95% rel. humidity, no dew-drop
<u>Weight</u>	MCSe 2.. 8	approx. 8 kg
	MCSe 9.. 16	approx. 13 kg

*) Fitted according to the order.

Wiring diagram is enclosed with the unit.

6.5 Hints to EMC (electro magnetic compatibility)

Interference transmissions:

The unit is relieved according to **EN 55011 /B** (interference transmissions).

Level of acceptance:

VDE 0839 Part 10

Reliability class	Z2
Ambient class	S2, I4, E3

Suppression:

VDE 0843 Part I 2,3,4

IEC 801 Part 2,4,5

Ambient class	3
Degree of strength	3, with external filter 4

6.6 Headword-index

Alarm contact	19, 24, 35, 36
Combined heating	6, 18, 26, 29, 30, 31
Commissioning	2, 28, 34
Control-loop-identification	6, 11, 28, 29
Leakage current	6, 12, 17, 18, 29, 34
Manual mode	7, 13, 33, 34
Output rate.....	8, 10, 13, 18, 19, 25, 27, 31
Report contact.....	24, 28
Selftuning	6, 7, 8, 9, 11, 16, 17, 23, 29, 32
Setpoint program	6, 14, 15, 23, 27, 28, 31
Softstart	6, 18, 26, 29
Start of the unit.....	11, 14
Trouble shooting	16, 17

Further headwords are listed in the contents.